

**WithWave's Precision Test Adapters** are designed based on precision microwave interconnection technologies. **This SMP(Female) to SMA(Female)** adapter is manufactured to precise microwave specifications and constructed with female gender on side 1 and female gender side 2. The precision microwave connector interfaces ensure an excellent microwave performance up to 26.5 GHz.



### ■ Features

- Frequency range : DC to 26.5 GHz
- VSWR(Max) : 1.30 : 1 (Max) @ 26.5 GHz
- Beryllium copper(gold plated) & Stainless steel(passivated)

### ■ Specification

Scope	Specification	AD05F06FS1
Electrical	Impedance(Ohm)	50
	Operation Freq.(GHz)	DC to 26.5 GHz
	VSWR (Max)	1.20 : 1 @ 18 GHz 1.30 : 1 @ 26.5 GHz
Material	Dielectric	Special dielectric
	Center Contact	Beryllium copper with gold plated
	Body	Beryllium copper with gold plated & Passivated stainless steel
	Operating Temperature	-40 to +125 °C

\* RoHS Compliant

### Drawing

Part No.: AD05F06FS1

Unit : mm

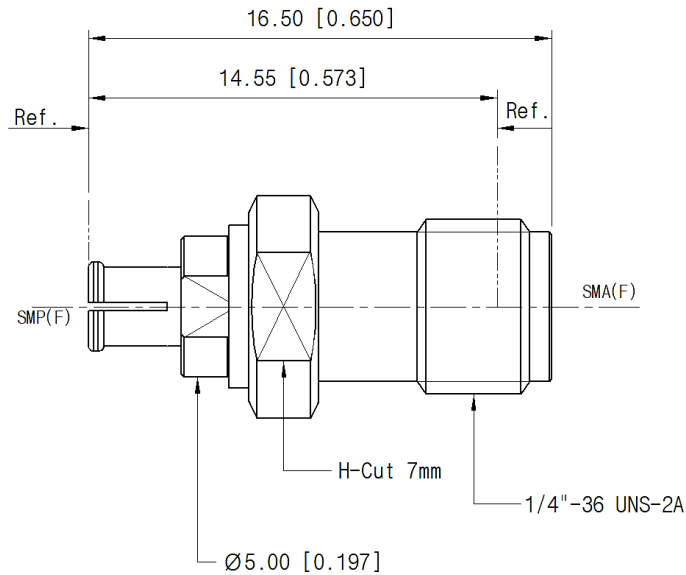

### Test Result

Frequency : 10 MHz to 26.5 GHz

