

Precision Test Adapters

1.85 mm(M) to 2.92 mm(M) : Right Angle type

WithWave's Precision Test Adapters are designed based on precision microwave interconnection technologies. This 1.85 mm(M) to 2.92 mm(M) **Right Angle adapter** is manufactured to precise microwave specifications and constructed with male gender on side 1 and male gender on side 2.

The precision microwave connector interfaces ensure an excellent microwave performance up to 40 GHz.



■ Features

- Frequency range : DC to 40 GHz
- VSWR(Max) : 1.20 : 1
- Body : Stainless steel (passivated)

■ Specification

Scope	Specification	AD01M03MR1
Electrical	Impedance(Ohm)	50
	Operation Freq.(GHz)	DC to 40 GHz
	VSWR (Max)	1.20 : 1
Material	Dielectric	Special dielectric
	Center Contact	Brass with gold plated
	Body	Passivated Stainless Steel
	Operating Temperature	-40 to +125 °C

* RoHS Compliant

Precision Test Adapters

1.85 mm(M) to 2.92 mm(M) : Right Angle type

■ Drawing

Part No.: AD01M03MR1

Unit : mm[inch]

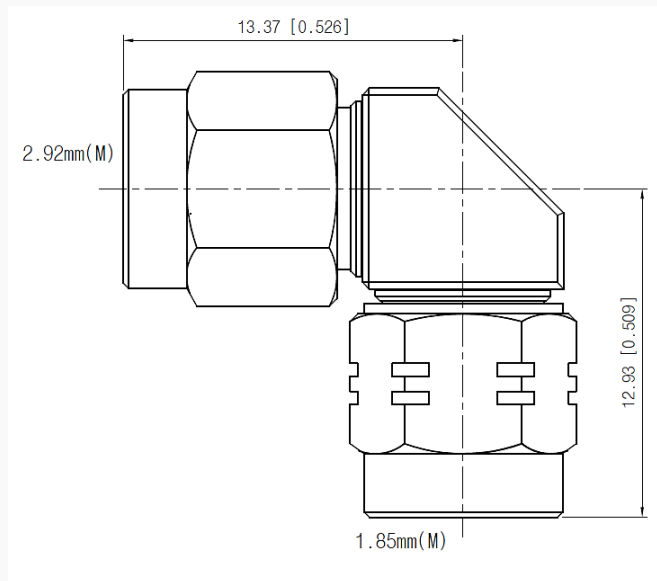

■ Test Result

▪ Frequency : 10 MHz to 40 GHz

