

Precision Test Adapters

1.85 mm(M) to 1.85 mm(M)

WithWave's Precision Test Adapters are designed based on precision microwave interconnection technologies. This 1.85 mm(M) to 1.85 mm(M) adapter is manufactured to precise microwave specifications and constructed with male gender on side 1 and male gender on side 2.

The precision microwave connector interfaces ensure an excellent microwave performance up to 67 GHz



■ Features

- Frequency range : DC to 67 GHz
- VSWR : 1.20: 1(Max) @ 67 GHz
- Stainless steel (passivated)

■ Specification

Scope	Specification	AD01M01MS1
Electrical	Impedance(Ohm)	50
	Operation Freq.(GHz)	DC to 67 GHz
	VSWR (Max)	1.20 : 1
Material	Dielectric	Special dielectric
	Center Contact	Brass with gold plated
	Body	Passivated Stainless Steel
	Operating Temperature	-40 to +125 °C

* RoHS Compliant

Precision Test Adapters

1.85 mm(M) to 1.85 mm(M)

■ Drawing

Part No.: AD01M01MS1

Unit : mm

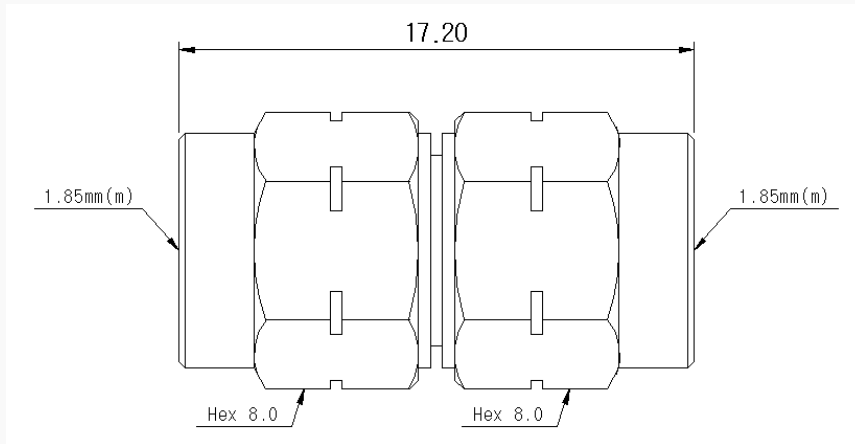

■ Test Result

▪ Frequency : 10 MHz to 67 GHz

