

<Specification>

1. Electrical
 - 1-1. Impedance : 50Ω
 - 1-2. Frequency range : DC to 40GHz
2. Material
 - 2-1. Body : Stainless Steel(Passivated)
 - 2-2. Pin : BeCu(Au Plated)
 - 2-3. Insulator : Ultem1000
3. Mechanical
 - 3-1. Durability : 500 Cycles

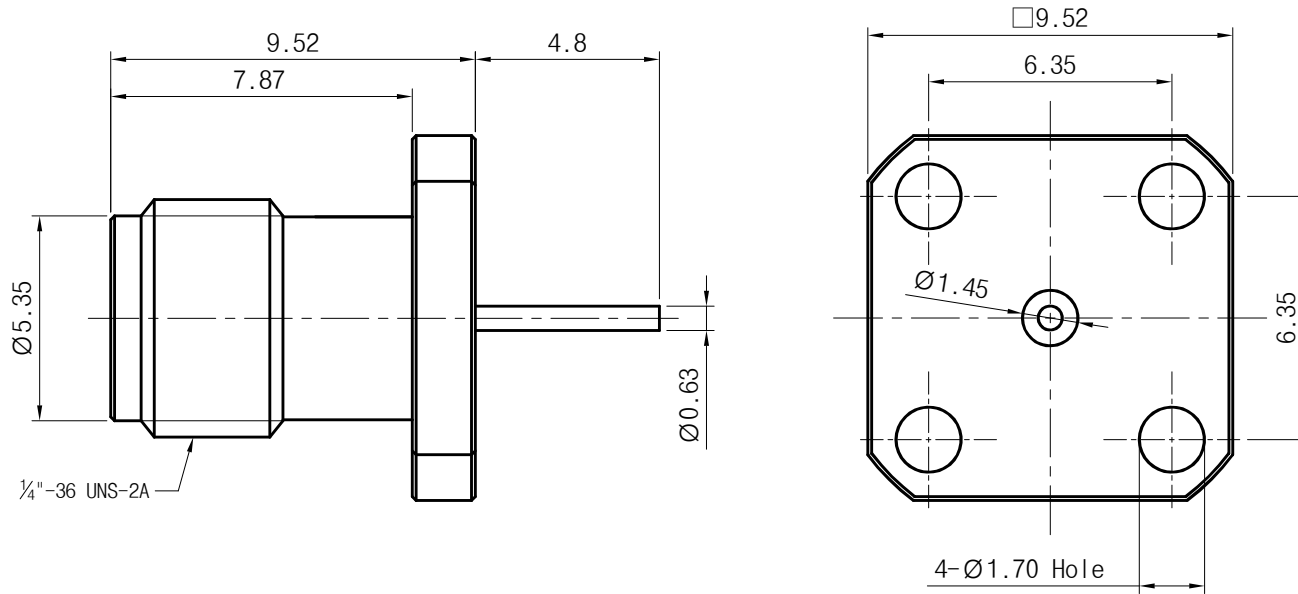

Title	2.92mm Wave Guide Connector 0.375 SQ, 4.80mm
Part No.	PM03FS058

THE INFORMATION HEREON/HEREIN IS PROPRIETARY TO WITH-WAVE CO., LTD. IT SHALL NOT BE COUPIED, DISCLOSED OR USED(PARTIALLY OR WHOLLY) IN ANY MANNER WITHOUT PRIOR EXPRESSED WRITTEN AUTHORIZATION OF WITH-WAVE CO., LTD.

Scale	N/A	Date	2018. 10. 10
Unit	mm[inch]	Drawn	Ter i K

withwave

Rev.
—