

<Specification>

1. Electrical
 - 1-1. Impedance : 50Ω
 - 1-2. Frequency range : DC to 34GHz
 - 1-3. VSWR(dB) : 1.2 : 1(-20.83dB)
2. Material
 - 2-1. Body : Stainless Steel(STS303)
 - 2-2. Pin : BeCu(C1720)
 - 2-3. Insulator : Ultem1000
 - 2-4. Coupling Nut : Stainless Steel(STS303)
3. Mechanical
 - 3-1. Durability : 500 Cycles

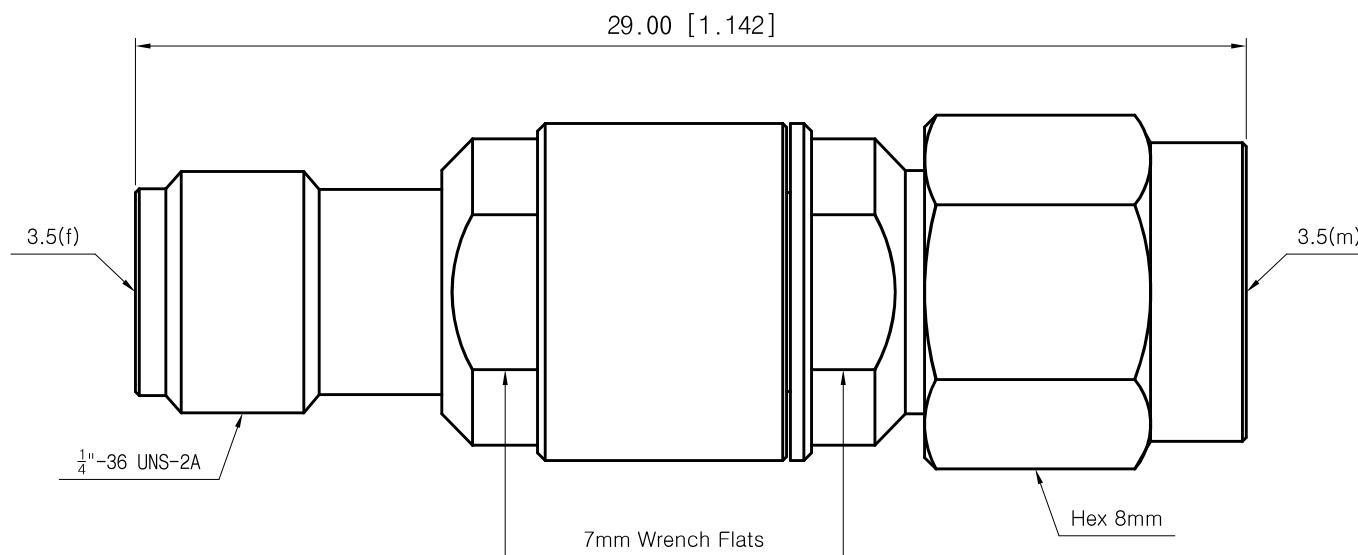

Title	3.5mm(M) to 3.5mm(F) Adapter
Part No.	AD04M04FS1

THE INFORMATION HEREON/HEREIN IS PROPRIETARY TO WITH-WAVE CO., LTD. IT SHALL NOT BE COUPIED, DISCLOSED OR USED(PARTIALLY OR WHOLLY) IN ANY MANNER WITHOUT PRIOR EXPRESSED WRITTEN AUTHORIZATION OF WITH-WAVE CO., LTD.

Scale	N/A	Date	2017. 07. 21
Unit	mm[inch]	Drawn	Teri K

withwave

Rev.
-