

A

B

C

D

E

F

<Specification>

- 1. Electrical
 - 1-1. Impedance : 50Ω
 - 1-2. Frequency range : DC to 40GHz
 - 1-3. VSWR(dB) : 1.2 : 1(-20.8dB)
- 2. Material
 - 2-1. Body : Stainless Steel(STS303)
 - 2-2. Pin : BeCu(C720)
 - 2-3. Insulator : Uitem1000
 - 2-4. Coupling Nut : Stainless Steel(STS303)
- 3. Mechanical
 - 3-1. Durability : 500 Cycles

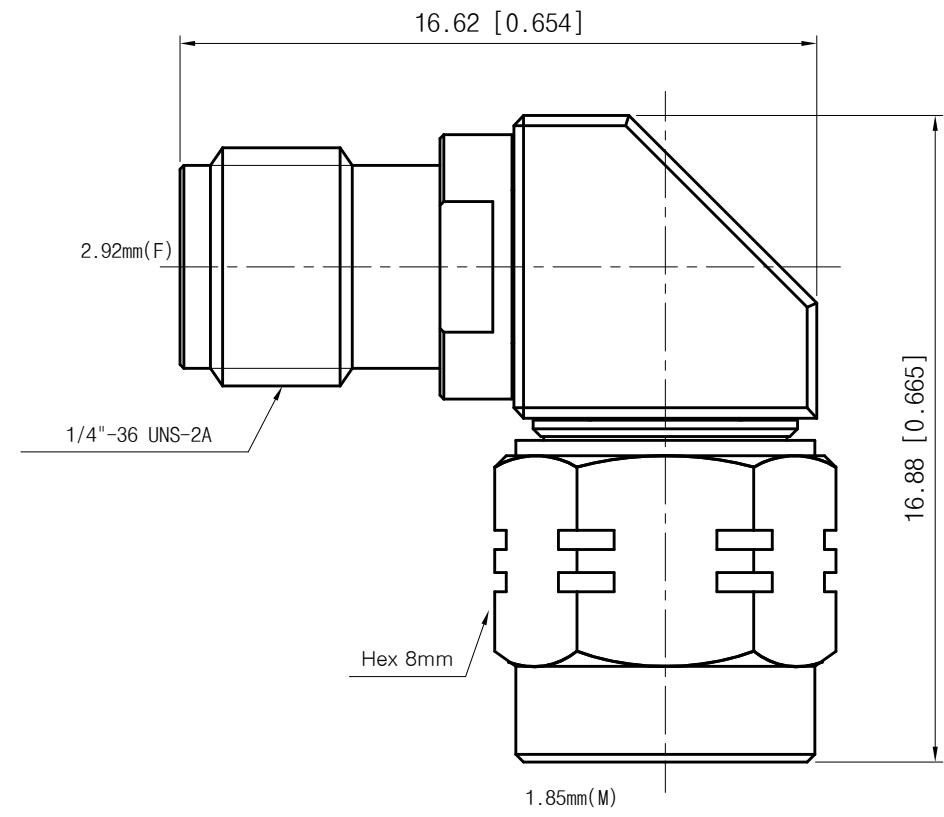

Title	1.85mm(M) to 2.92mm(F) Right Angle type Adapter
Part No.	AD01M03FR1

THE INFORMATION HEREON/HEREIN IS PROPRIETARY TO WITH-WAVE CO., LTD. IT SHALL NOT BE COUPIED, DISCLOSED OR USED(PARTIALLY OR WHOLLY) IN ANY MANNER WITHOUT PRIOR EXPRESSED WRITTEN AUTHORIZATION OF WITH-WAVE CO., LTD.

Scale	N/A	Date	2019. 04. 01
Unit	mm[inch]	Drawn	Ter i K

withwave Rev. —

A

B

C

D

E

F