

High Speed Cable Assembly



High Speed Cable Assembly

(56Gbps NRZ)

Cable (32AWG)

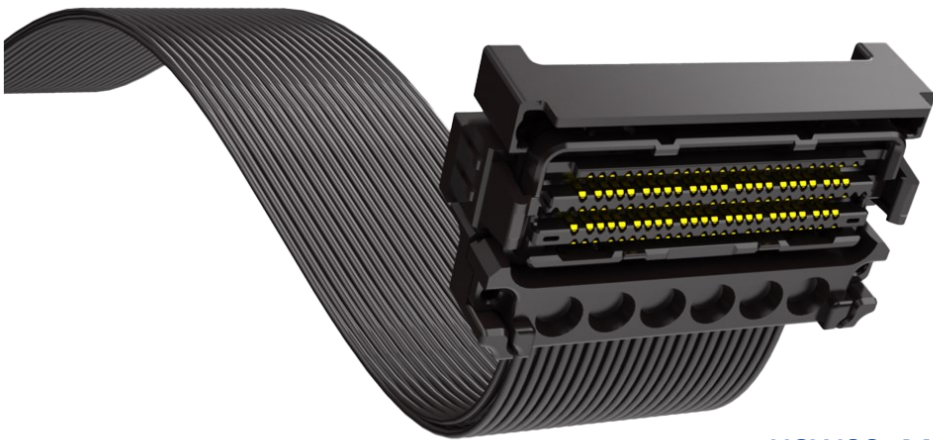

HSW00_M120R



Quick Lock

Connector type	Part No.
Vertical	HSW00_M120S
Right - Angle	HSW00_M120R
Board Connector	HSB02L_M120S

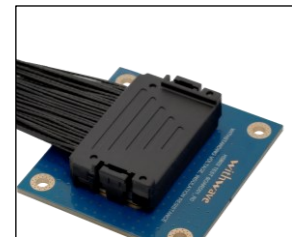

● Features

- Higher bandwidth application : 56Gbps NRZ
- 24 differential pairs
- Pitch : 0.9mm x 1.5mm
- Differential pair 92 Ohm nominal impedance
- Surface mount BGA pin design
- External dimensions
 - . HSW00_M120R : 38.3mm(W) x 22.0mm(D) x 10.45mm(H)
 - . HSW00_M120S : 38.3mm(W) x 18.5mm(D) x 16.55mm(H)
- Cable Type : Differential cable, Single-ended cable, or Mixed assembly

High Speed Characterization

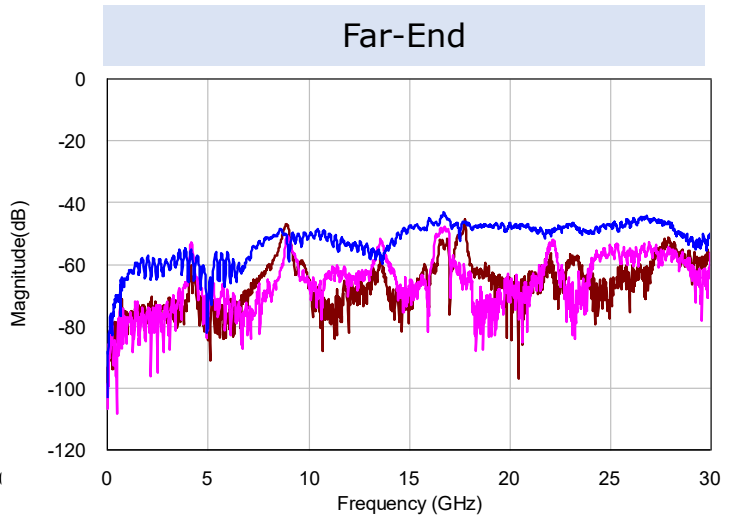
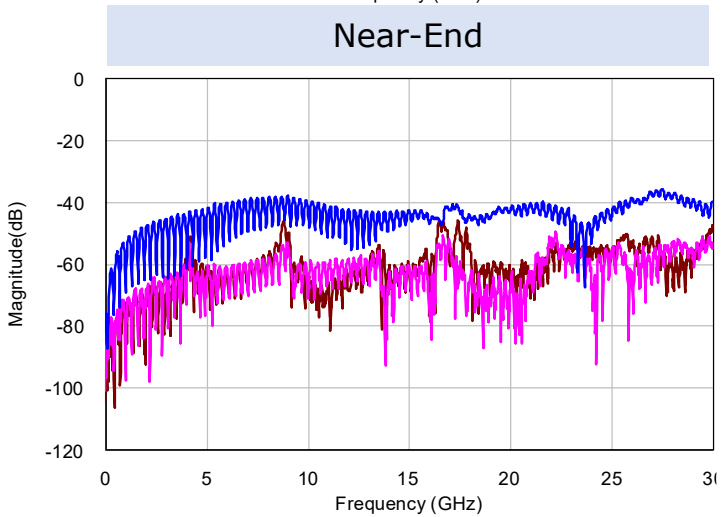
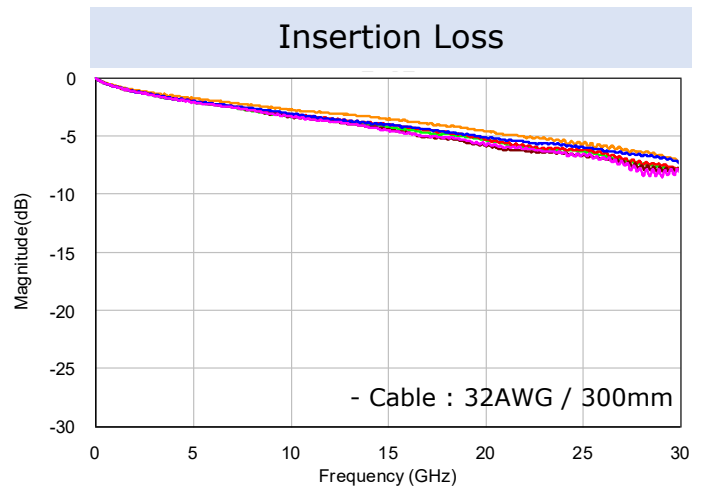
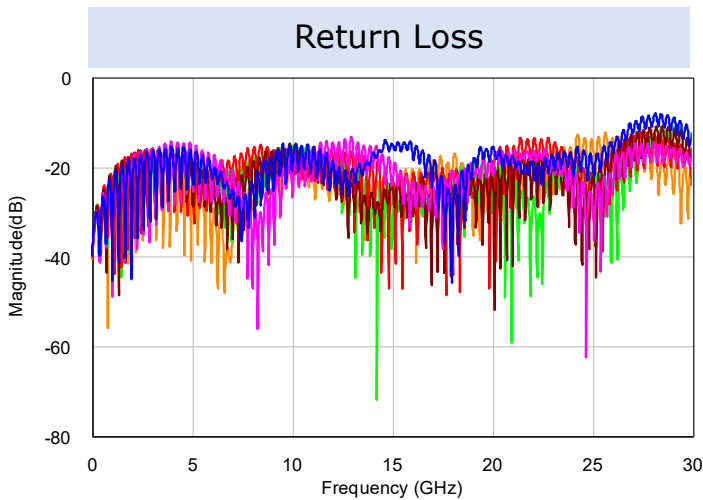
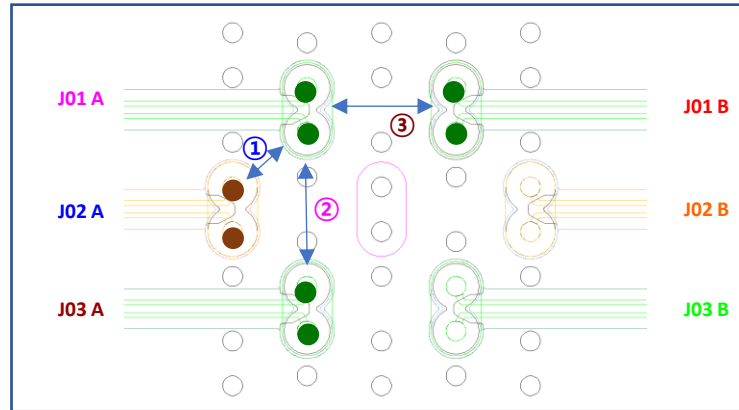

Cable Flexibility

The changes in LLCR, IL after **500,000 cycles at ±90 degrees** are as follows.

LLCR : Δ 10m Ω Average

Insertion Loss : Δ 0.4dB @14GHz

Δ 1.0dB @28GHz

Bending Cycles	500,000 Cycles
Bending Angle	±90°
Test Speed	40 r/min.
Tensile Force	20g
Bending Radius	5mm

- Cable : 32AWG Single-ended

Cable Assembly

Mate : HSB02L_M120S01H050A

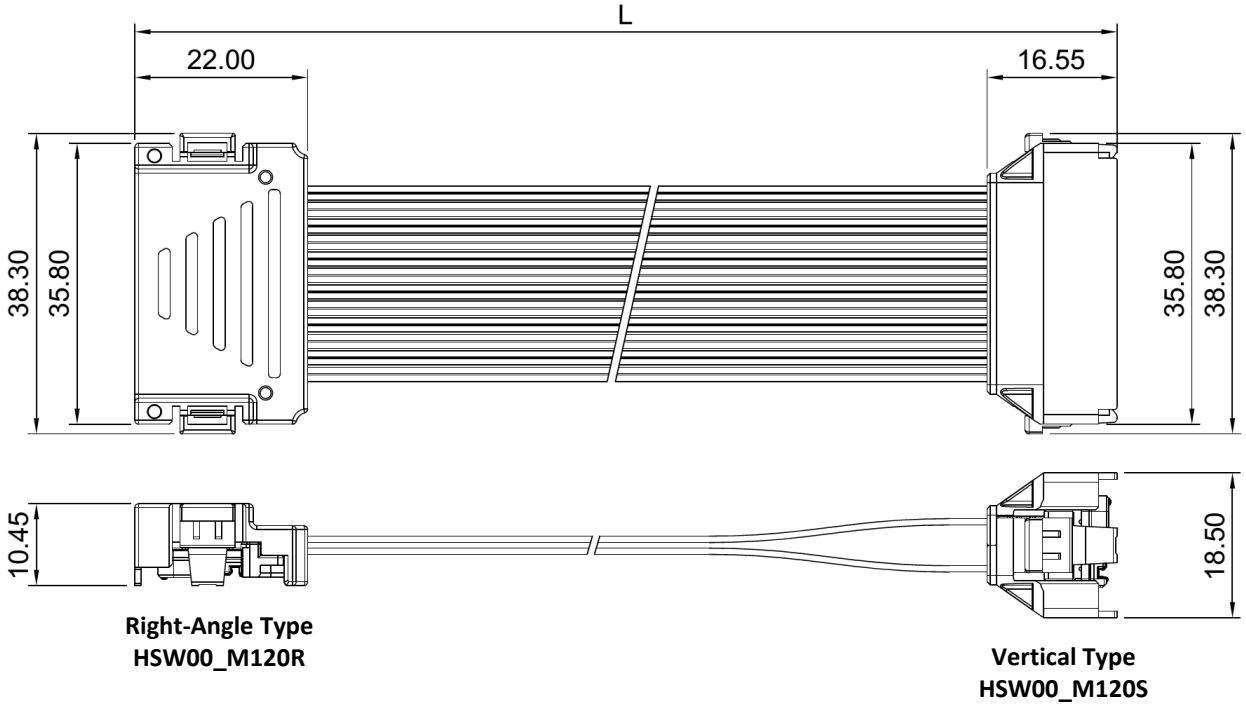
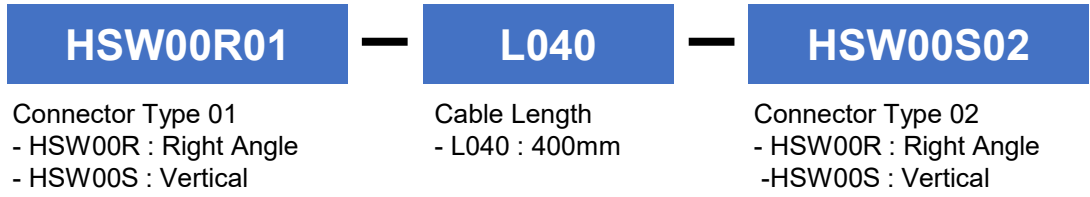

Connector (HSB02L_M120S01H050A)

Mate : Cable assembly

