

Wave Launch™ connectors are specially designed for well-used high frequency substrates to minimize Electromagnetic effects including impedance discontinuities from coaxial to Microstrip structure. We solve your performance and cost problems.

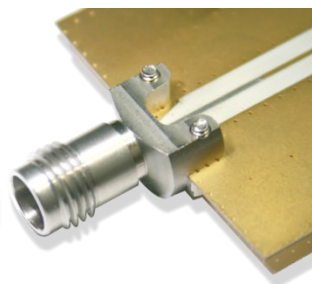

■ Features

- Now available in : SMA (27 GHz), 2.92 mm (40 GHz), 2.40 mm (50 GHz), 1.85 mm (67 GHz)
- Optimized **well-used high frequency substrates (RO4003C, RO4350B, Du5880)**
- according to substrate thickness (5, 8, 10, 12 mil)
- Easy Installation on designed substrate



Substrate	Thickness(mil)	Dielectric Constant	Available Wave Launch Connector		
			SMA	2.92mm	2.4mm
RO4003C	8.0	3.55	○	○	○
	12.0		○	○	○
RO4350B	10.0	3.65	○	○	○
Du5880	5.0	2.20	○	○	○
	10.0		○	○	○

■ Application

- RFIC Chip set evaluation board
- High data rate ASIC and SoC evaluation module test
- Substrate Characterization

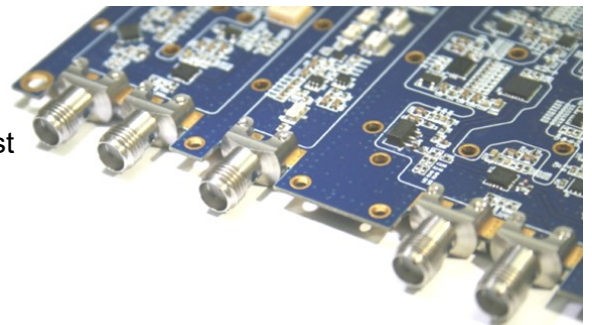

■ Design Assistance

- 3D Model for Mechanical Layout (STEP file)
- **ANSYS HFSS models** (version 17.0 or newer) for 3D EM(Electromagnetic) Simulation

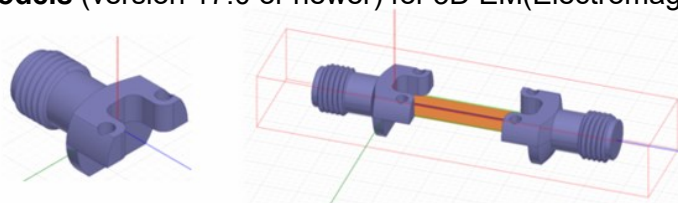

■ Specification (Board Edge Type)

Scope	Items	Specification
Electrical	Freq. range	DC to 27 GHz (SMA type) DC to 40 GHz (2.92 mm type) DC to 50 GHz (2.4 mm type) DC to 67 GHz (1.85 mm type)
	Impedance	50 Ohm
	VSWR(Max)	1.34 : 1 (to 50 GHz)
Material	Connector type	SMA, 2.92 mm, 2.4 mm, 1.85 mm
	Body & Block	Stainless Steel
	Contact	BeCu with Gold Plated
	Operating Temperature	-40~+125°C

* RoHS Compliant

■ Measurement data



- Connector : 2.4 mm
- Substrate : RO4350B(10 mil)
- Trace length : 40 mm (microstrip)

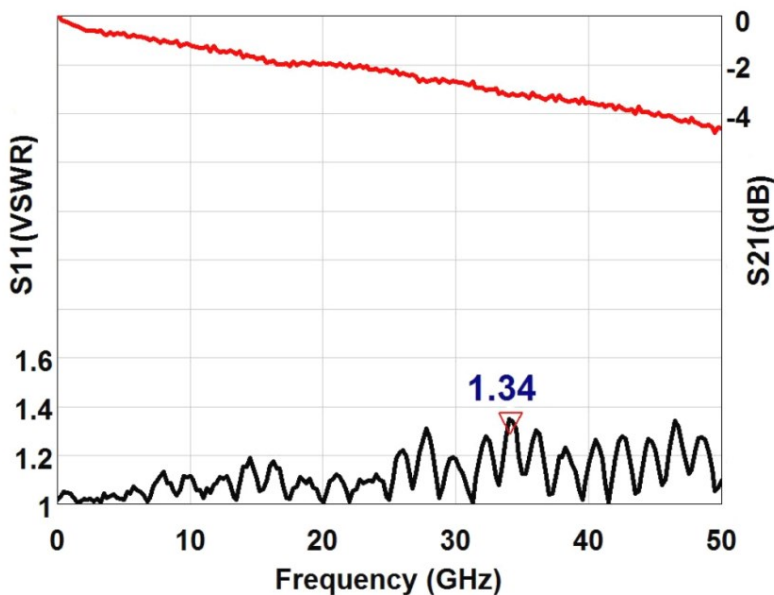

Ordering Information

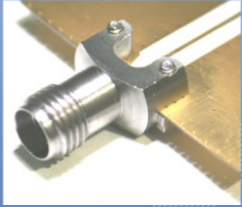

- **Board Edge Type**
- No need of ground soldering
- Easy installation

Substrate	Thickness(mil)	Wave Launch Connector		
		SMA	2.92mm	2.4mm
RO4003C	8.0	SM06FS001	SM03FS001	SM02FS001
	12.0	SM06FS002	SM03FS002	SM02FS002
RO4350B	10.0	SM06FS003	SM03FS003	SM02FS003
Du5880	5.0	SM06FS004	SM03FS004	SM02FS004
	10.0	SM06FS005	SM03FS005	SM02FS005



- **Panel Mount Type**
- No need of glass bead
- Simple circuit housing design

Substrate	Thickness(mil)	Part Number		
		SMA	2.92mm	2.4mm
RO4003C	8.0	PM06FS001	PM03FS001	PM02FS001
	12.0	PM06FS002	PM03FS002	PM02FS002
RO4350B	10.0	PM06FS003	PM03FS003	PM02FS003
Du5880	5.0	PM06FS004	PM03FS004	PM02FS004
	10.0	PM06FS005	PM03FS005	PM02FS005

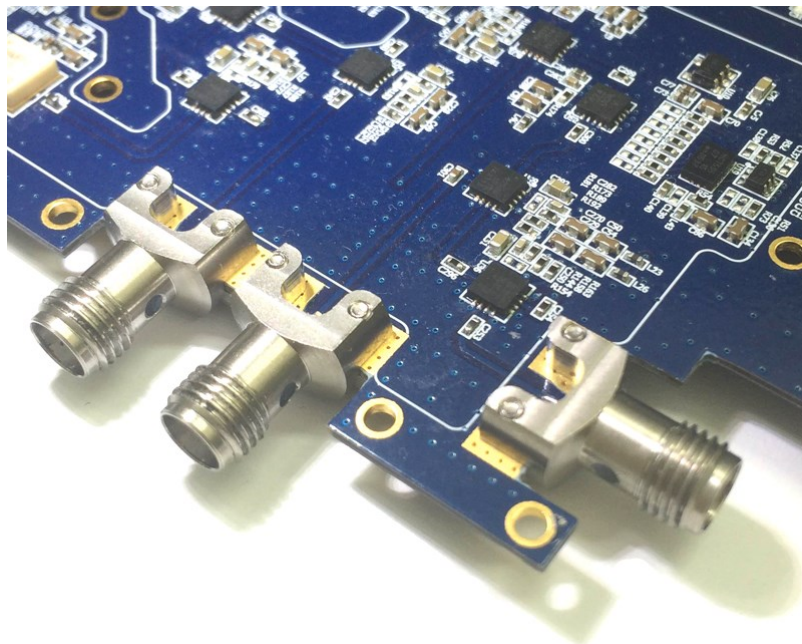

■ Installation Procedure

STEP 1 :

Insert wave launch connector (including ground block & screws) in the edge position of substrate.

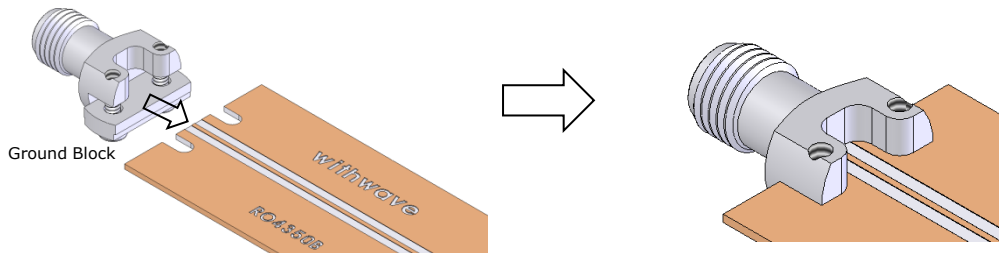

STEP 2:

Ensure ground block should be tighten against the substrate using two screws while ensuring flat pin should be centered on the trace.

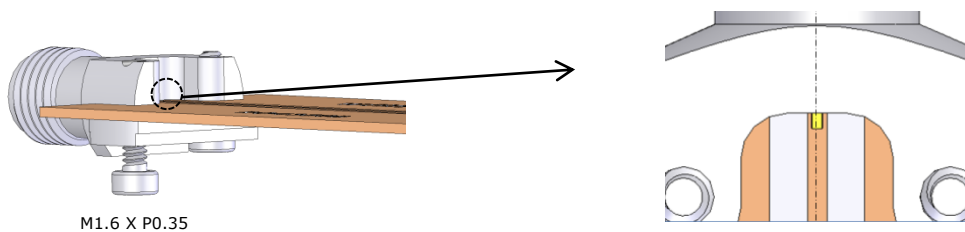

STEP 3:

Solder the flat pin to center trace on substrate while ensuring the connector is held in the correct position.
(Note: solder should flow along the length of the exposed flat pin for good electrical performance)

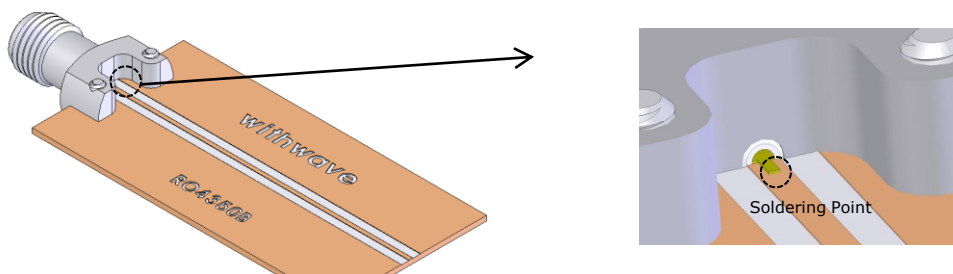

STEP 4:

Remove any excess solder and clean all flux and other residues from the trace.



■ Design Guideline

1. Wave Launch Connectors are optimized for well-used high frequency substrate **with microstrip structure**. If you use **multi-layer PCB including FR4 substrate** (see below), we recommend following PCB layout for good performance in the range of high frequency.

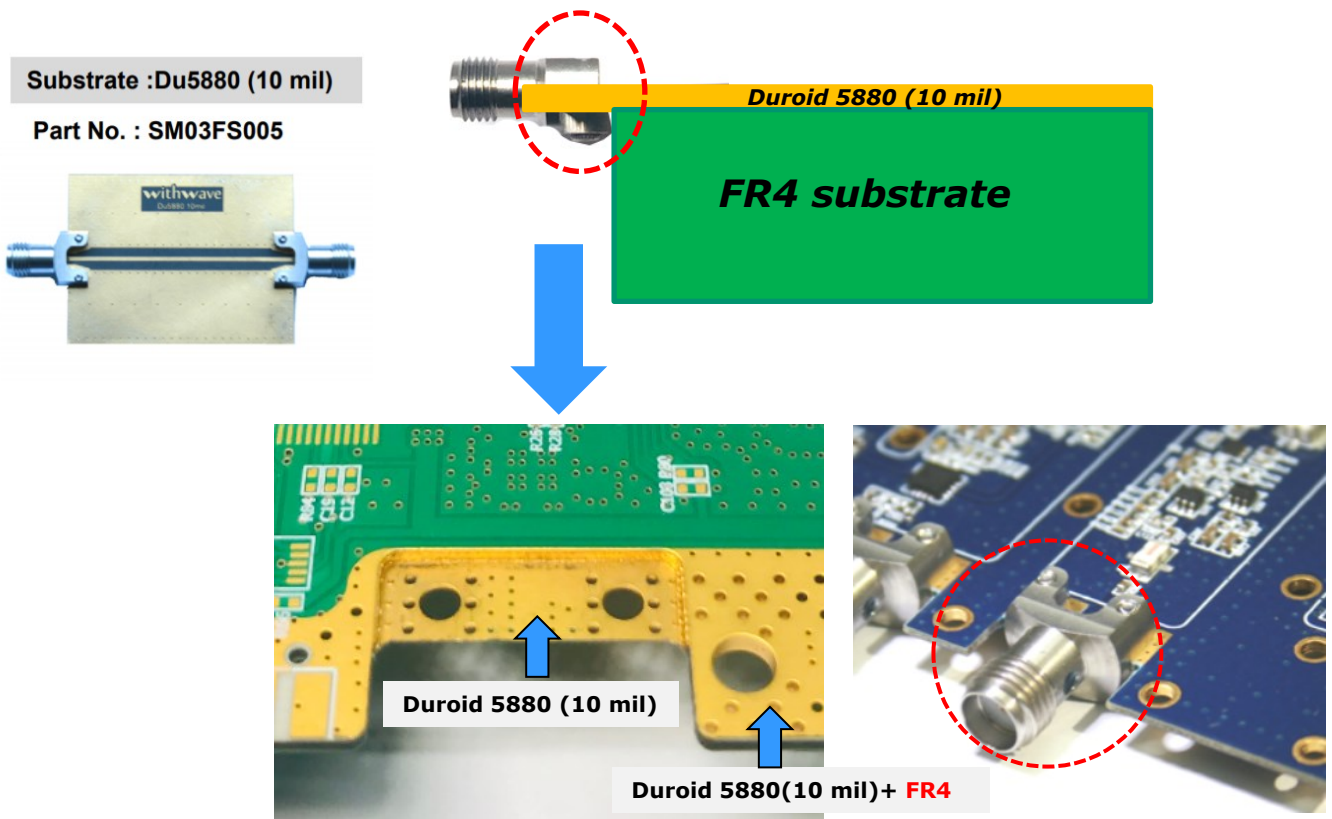

2. The edge of substrate should be contacted to body of connector directly. zero gap between substrate and body of connector is important to get good performance at the range of high frequency.

Zero gap between substrate and body of connector for good performance at the range of high frequency.

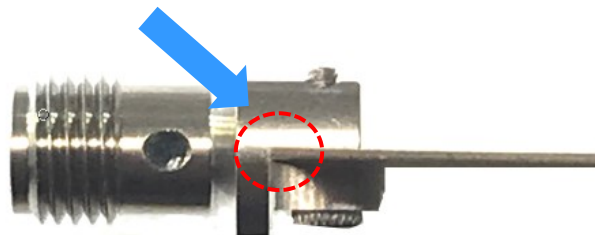

Test Result

SMA Type

Freq. : 10 MHz to 26.5 GHz

Substrate : RO4003C (8 mil)

Part No. : SM06FS001

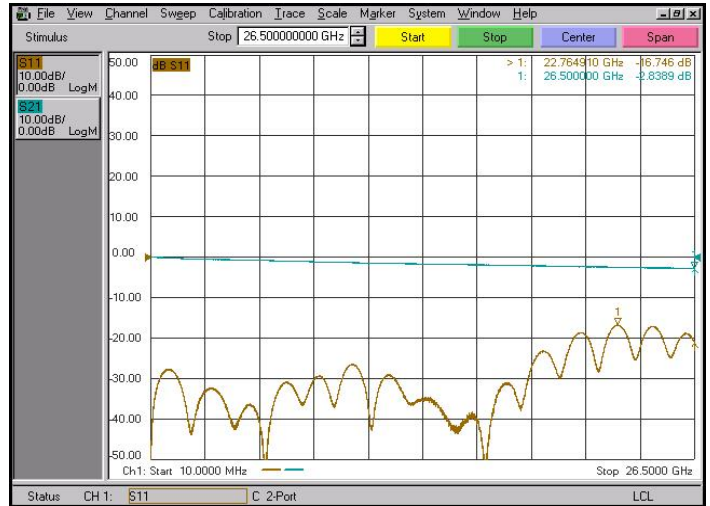

Substrate :RO4003C (12 mil)

Part No. : SM06FS002

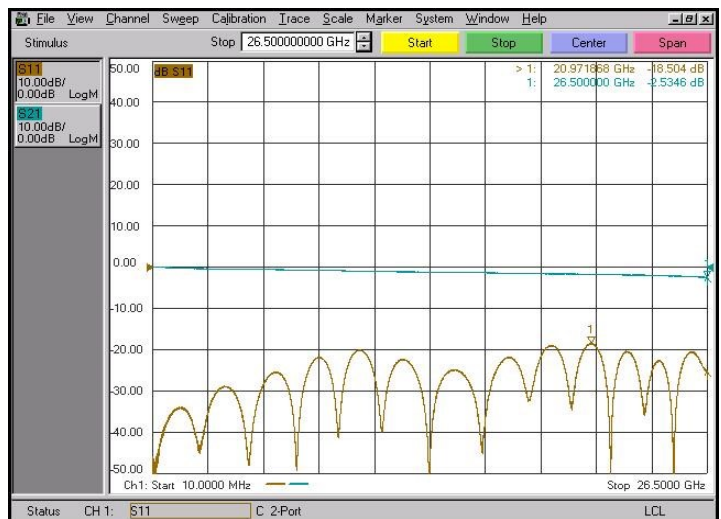

Substrate :RO4350B (10 mil)

Part No. : SM06FS003

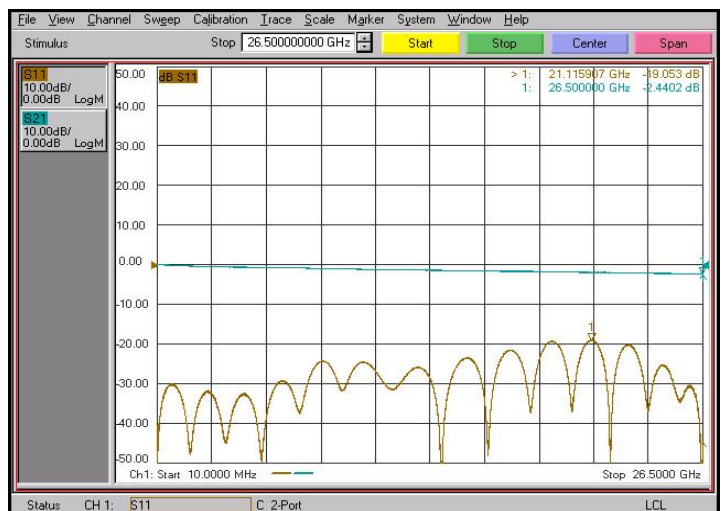

** Trace length : 40 mm (Microstrip) **

Test Result

SMA Type

Freq. : 10 MHz to 26.5 GHz

Substrate : Du5880 (5 mil)

Part No. : SM06FS004

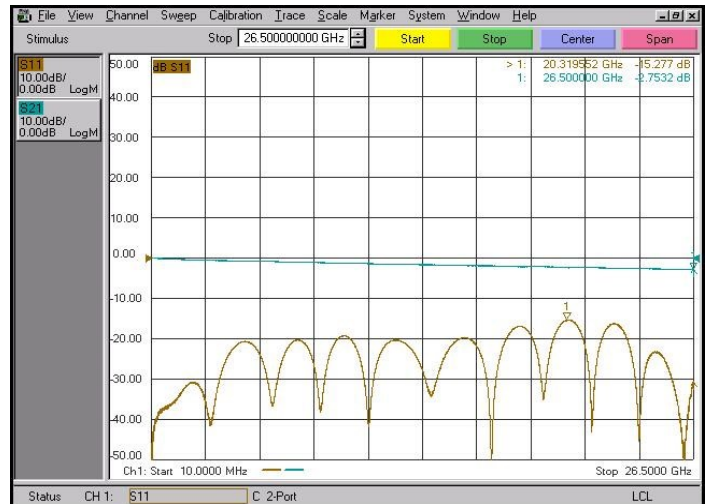

Substrate : Du5880 (10 mil)

Part No. : SM06FS005

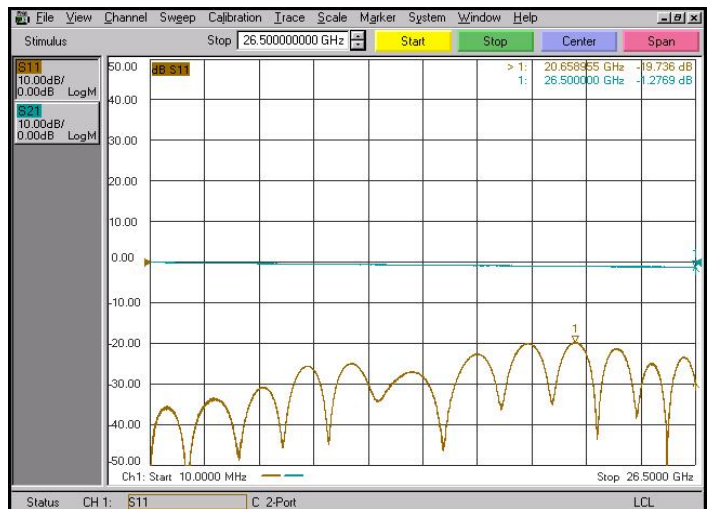

** Trace length : 40 mm (Microstrip) **



Test Result

2.92mm Type

Freq. : 10 MHz to 40 GHz

Substrate : RO4003C (8 mil)

Part No. : SM03FS001

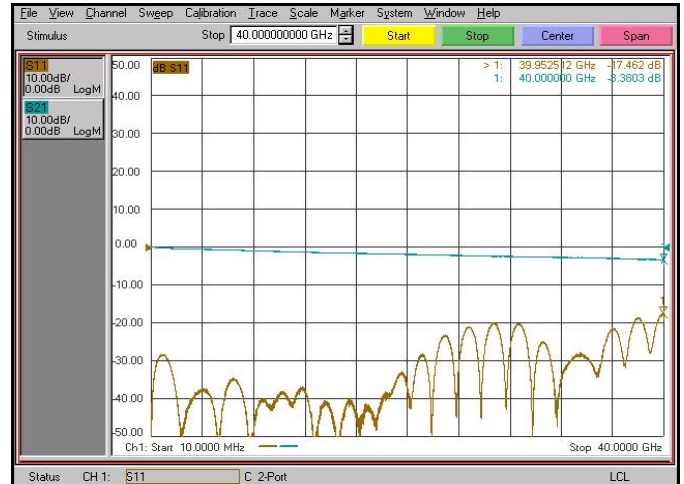

Substrate :RO4003C (12 mil)

Part No. : SM03FS002

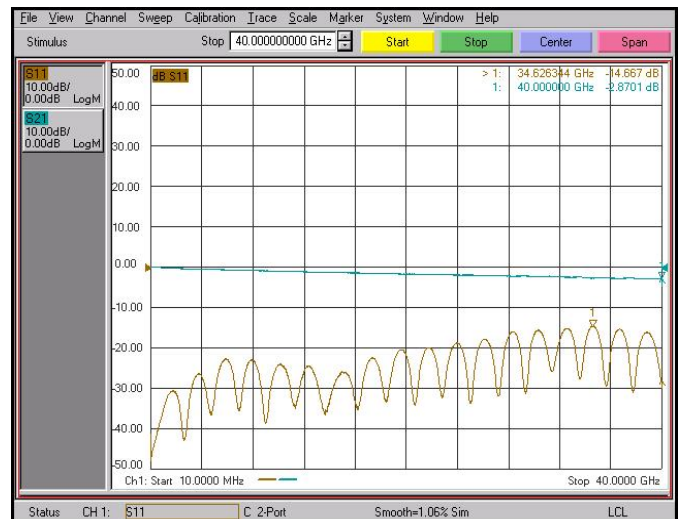

Substrate :RO4350B (10 mil)

Part No. : SM03FS003

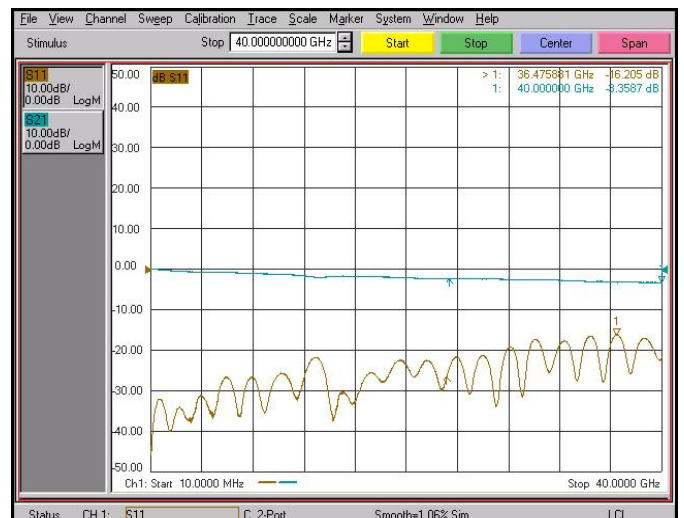

** Trace length : 40 mm (Microstrip) **

■ Test Result

2.92mm Type

Freq. : 10 MHz to 40 GHz

Substrate : Du5880 (5 mil)

Part No. : SM03FS004

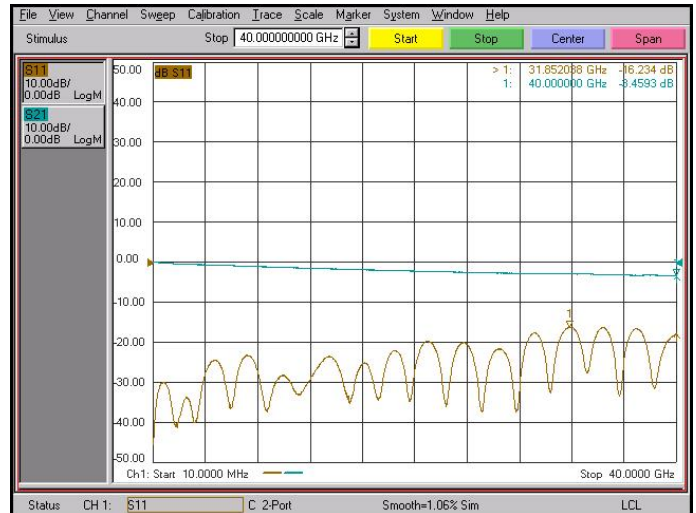

Substrate : Du5880 (10 mil)

Part No. : SM03FS005

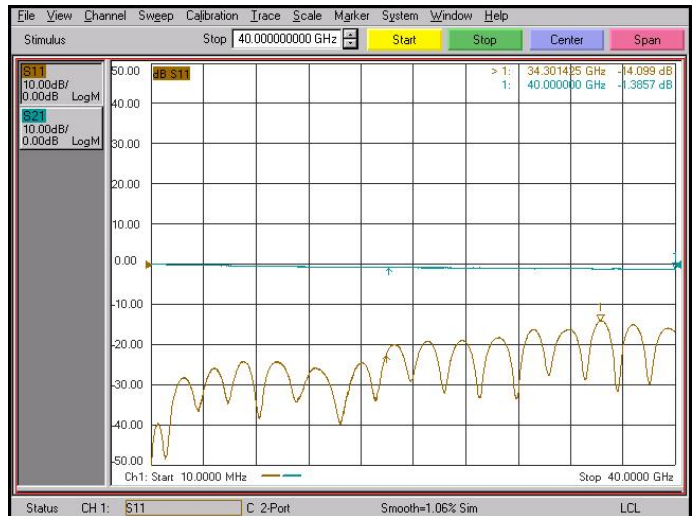

** Trace length : 40 mm (Microstrip) **



Test Result

2.4mm Type

Freq. : 10 MHz to 50 GHz

Substrate : RO4003C (8 mil)

Part No. : SM02FS001

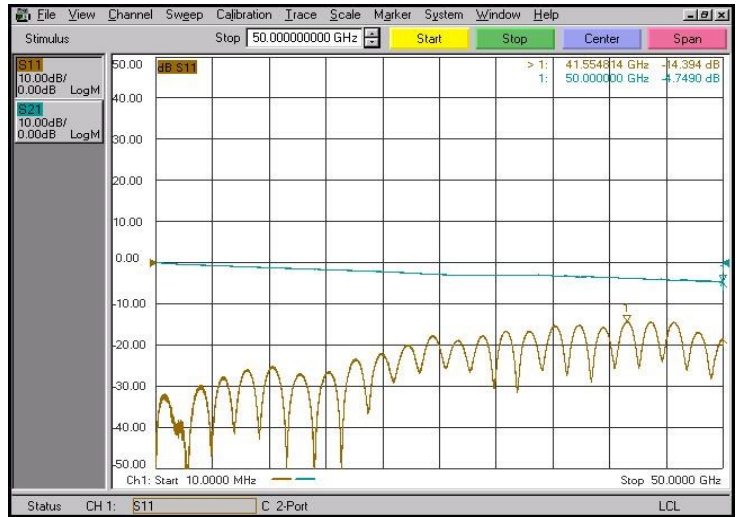

Substrate :RO4003C(12 mil)

Part No. : SM02FS002



Substrate :RO4350B (10 mil)

Part No. : SM02FS003

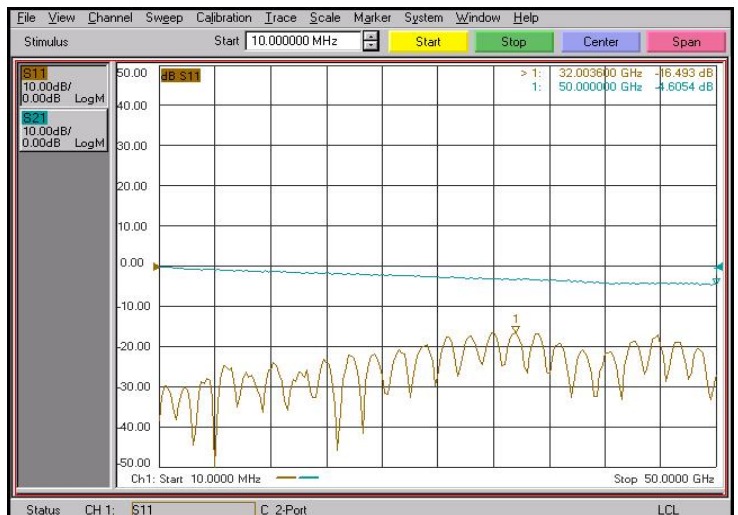

** Trace length : 40 mm (Microstrip) **

■ **Test Result**

2.4mm Type

Freq. : 10 MHz to 50 GHz

Substrate : Du5880 (5 mil)

Part No. : SM02FS004

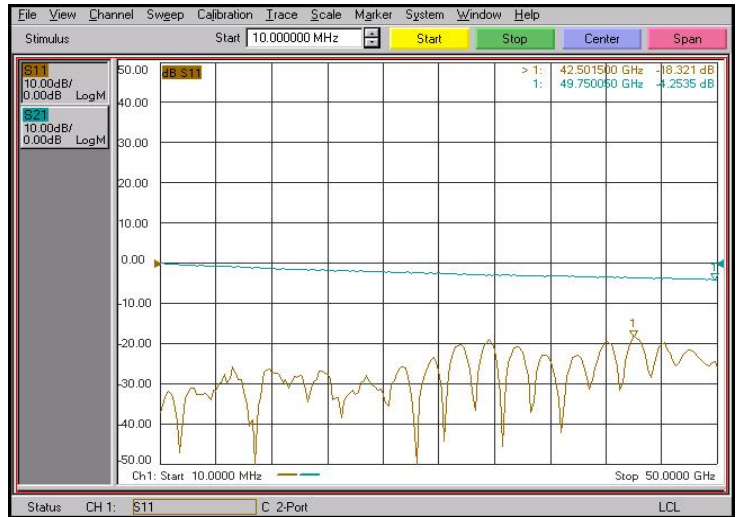

Substrate : Du5880 (10 mil)

Part No. : SM02FS005

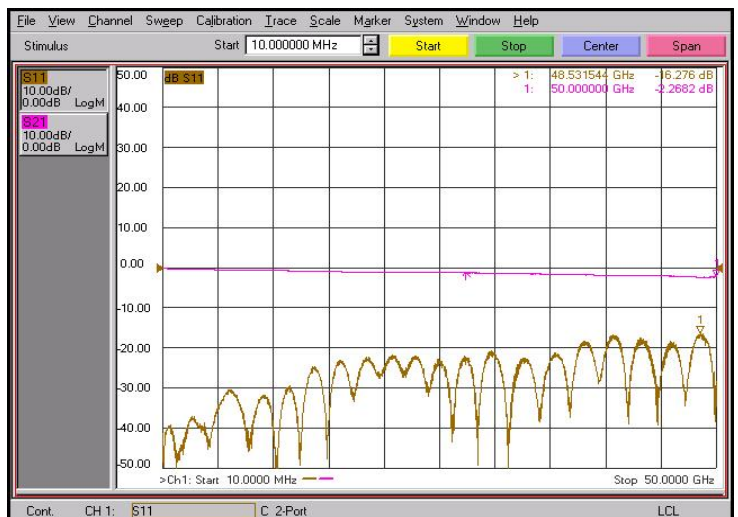

** Trace length : 40 mm (Microstrip) **

■ Test Result

1.85 mm Type

Substrate : Du5880 (5 mil)

Part No. : SM01FS004



** Trace length : 40 mm (Microstrip) **

Freq. : 10 MHz to 65 GHz

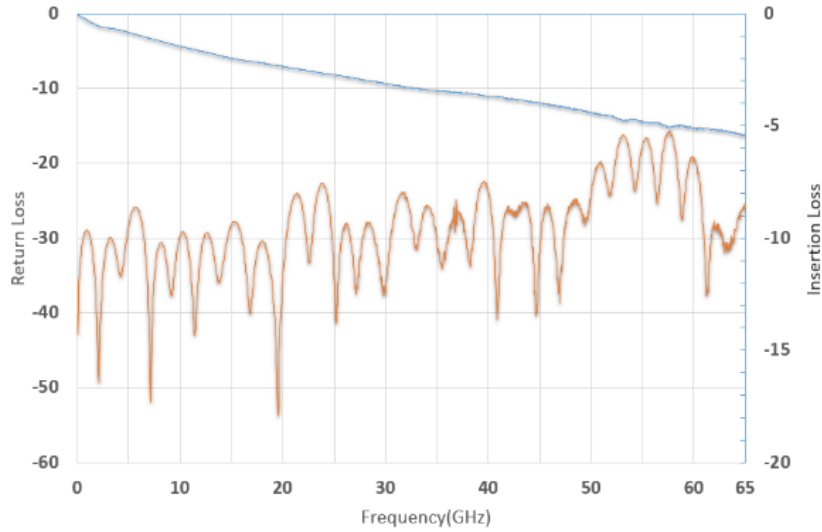

■ Drawing

SMA Type

Unit : mm

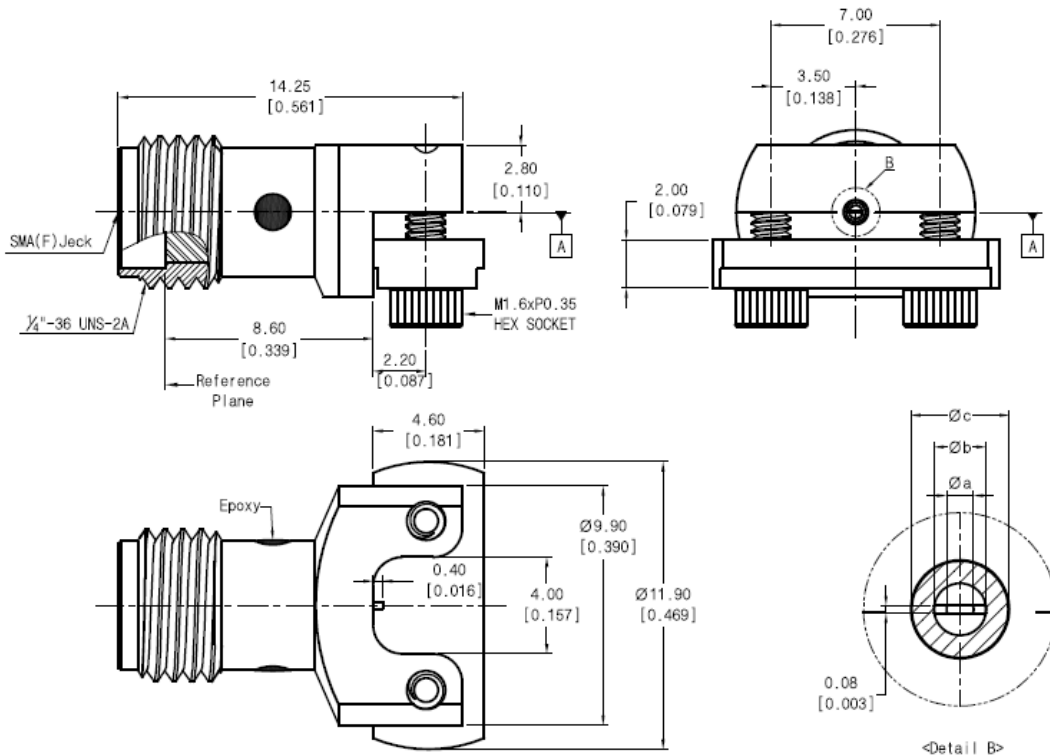

<Recommended pattern>

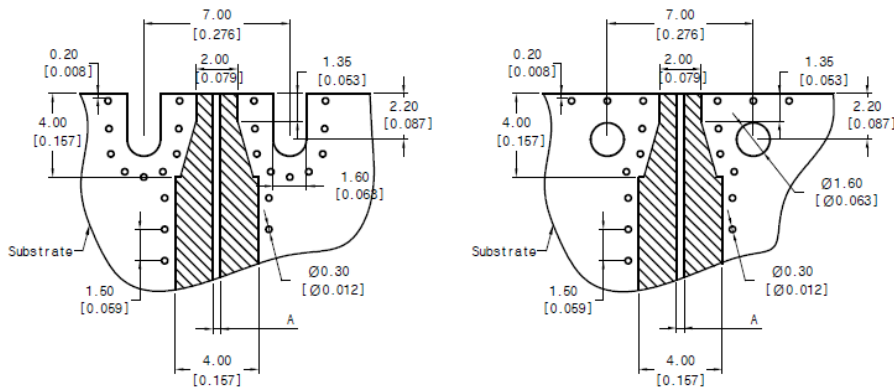

SMA(26.5GHz)

Type	PCB		Pin Diameter		Dielectric Dia.	Part No.
	Thickness mil	Signal width(A)	øa	øb	øc	
RO4003C	8.0	0.436	0.28	0.42	0.82	SM06FS001
	12.0	0.677	0.40	0.64	1.14	SM06FS002
RO4350B	10.0	0.545	0.28	0.54	1.00	SM06FS003
Du5880	5.0	0.366	0.28	0.34	0.70	SM06FS004
	10.0	0.765	0.40	0.72	1.24	SM06FS005

■ Drawing

2.92 mm Type

Unit : mm

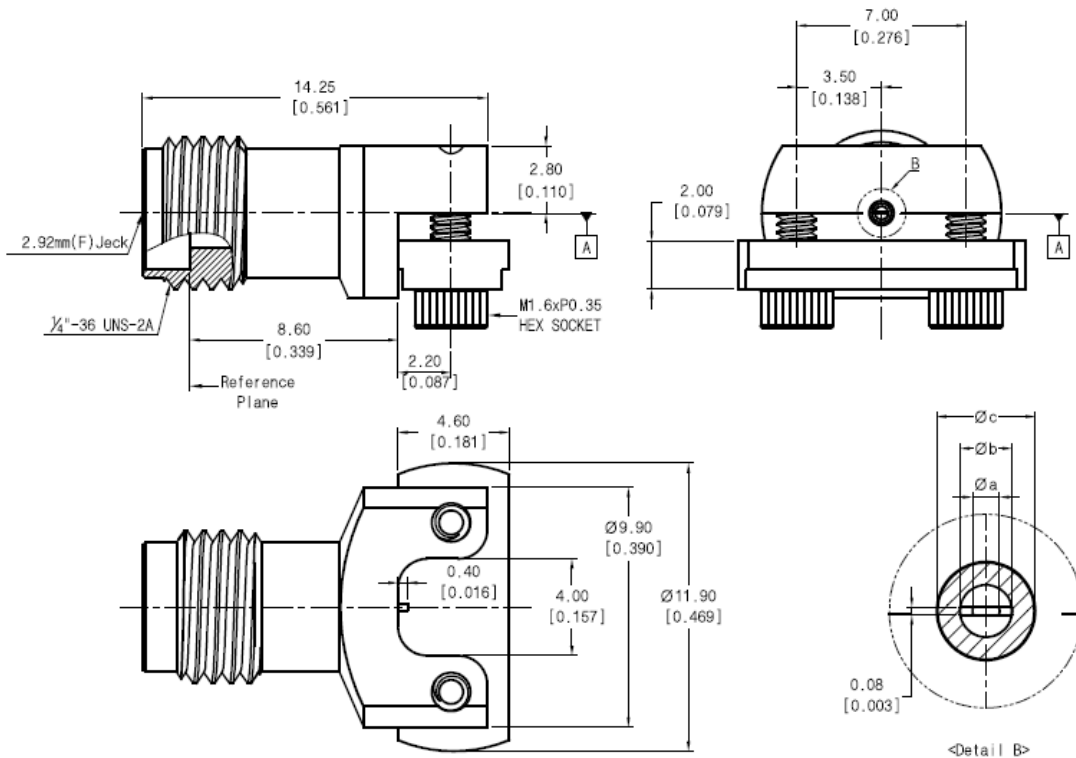

<Recommended pattern>

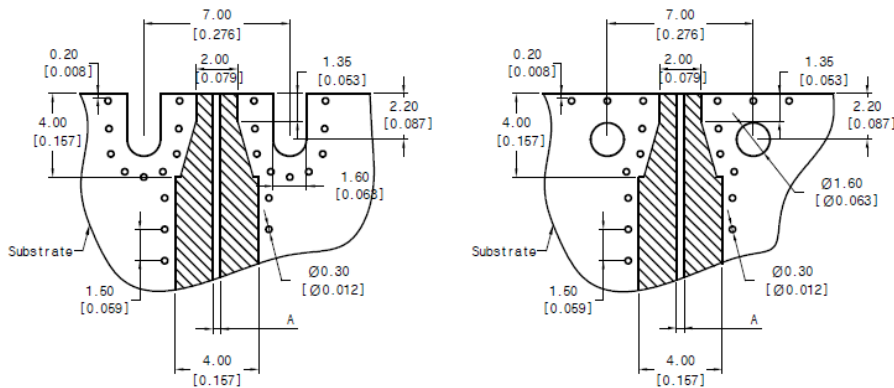

2.92mm(40GHz)

Type	PCB		Pin Diameter		Dielectric Dia.	Part No.
	Thickness	Signal width(A)	Øa	Øb	Øc	
	mil		mm			
RO4003C	8.0	0.436	0.28	0.42	0.82	SM03FS001
	12.0	0.677	0.40	0.64	1.14	SM03FS002
RO4350B	10.0	0.545	0.28	0.54	1.00	SM03FS003
Du5880	5.0	0.366	0.28	0.34	0.70	SM03FS004
	10.0	0.765	0.40	0.72	1.24	SM03FS005

■ Drawing

2.4 mm Type

Unit : mm

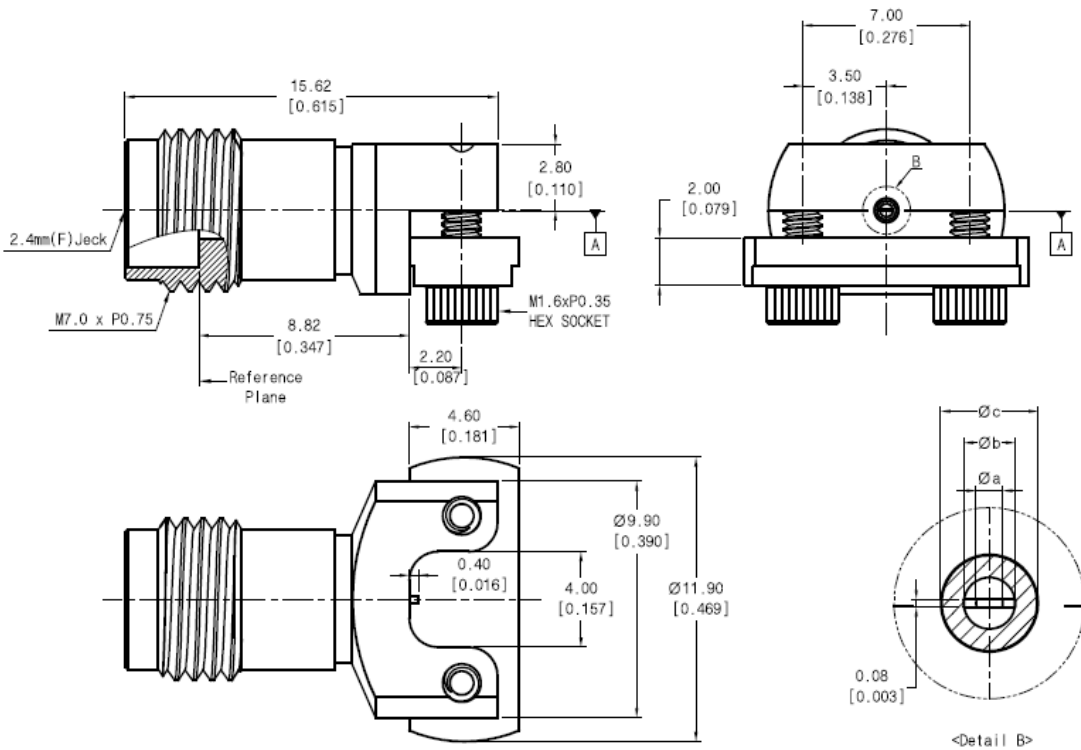

<Recommended pattern>

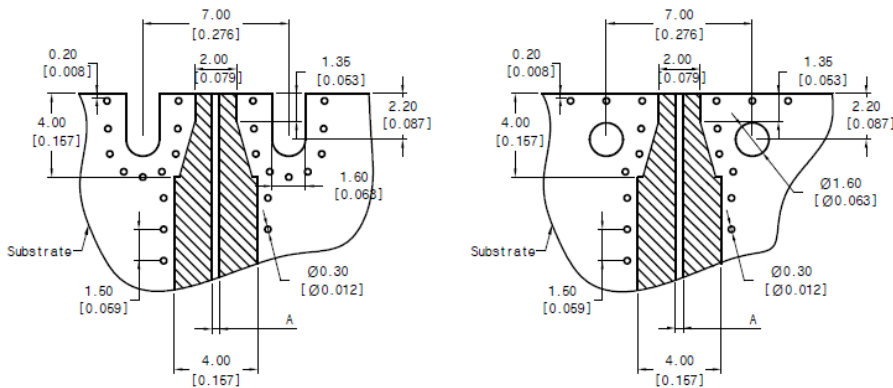

2.4mm(50GHz)

Type	PCB		Pin Diameter		Dielectric Dia.	Part No.
	Thickness	Signal width(A)	$\varnothing a$	$\varnothing b$	$\varnothing c$	
	mil	mm	mm			
RO4003C	8.0	0.436	0.28	0.42	0.82	SM02FS001
	12.0	0.677	0.40	0.64	1.14	SM02FS002
RO4350B	10.0	0.545	0.28	0.54	1.00	SM02FS003
Du5880	5.0	0.366	0.28	0.34	0.70	SM02FS004
	10.0	0.765	0.40	0.72	1.24	SM02FS005

■ Drawing

1.85 mm Type

Unit : mm

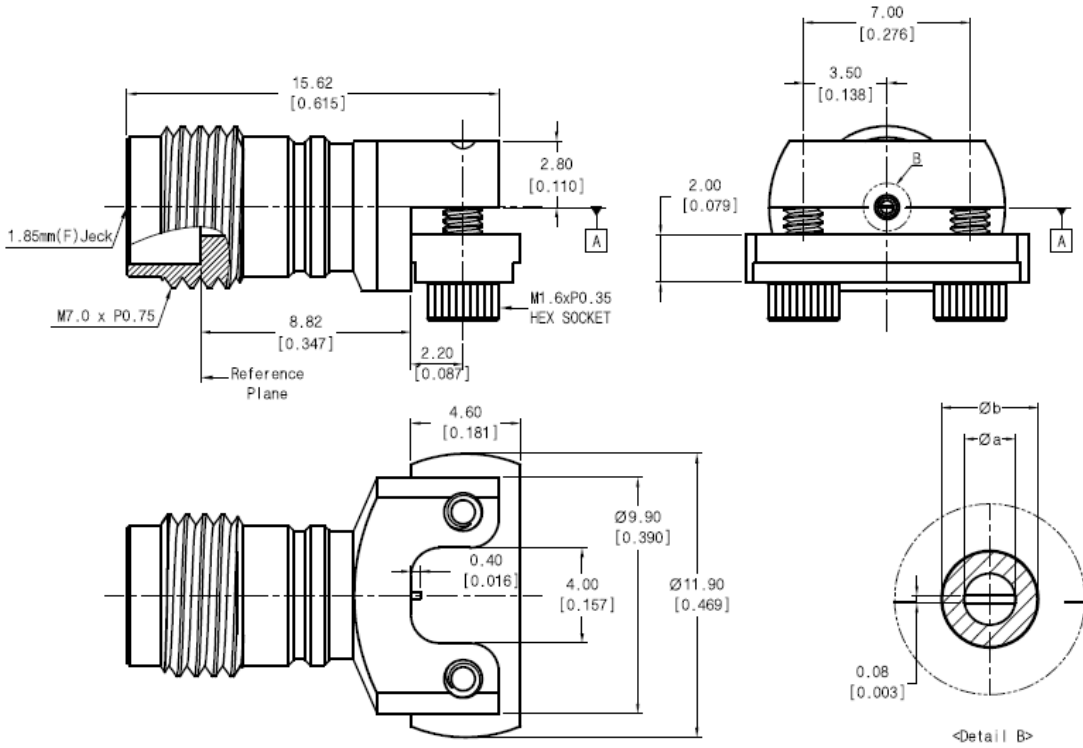

<Recommended pattern>

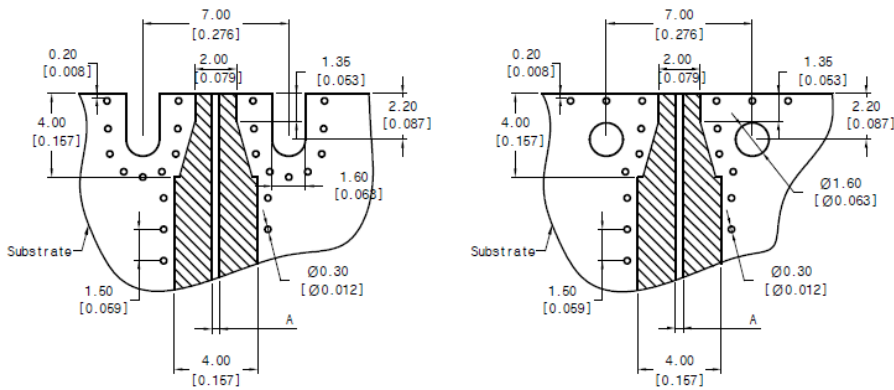

1.85mm(67GHz)

Type	PCB		Pin Diameter	Die. Dia.	Part No.
	Thickness	Signal width(A)	Øa	Øb	
	mil		mm		
Du5880	5.0	0.366	0.28	0.62	SM01FS004

■ Revision History

Revision	Date	Changes
Ver 1.4	2016-02-27	Changed installation procedure in detail
Ver 1.5	2016-03-17	Add drawing of another PCB recommended pattern
Ver 1.6	2016-06-09	Update of test results of 2.4 mm type for RO4350B, Du5880 Substrate
Ver 1.7	2017-05-22	Add 1.85 mm type
Ver 1.8	2018-04-05	Add test results of 2.4 mm type for RO4003C, Du5880 10 mil
Ver 1.9	2019-07-30	Add Design guideline
Ver 2.0	2020-03-01	Add Design Assistance for ANSYS HFSS 3D model
Ver 2.1	2021-08-17	Update Recommended PCB Patterns